

X8 ARMAGEDDON D2

Speaker Specification

Power	P	1300 / 5000*	RMS/SPL
DC resistance	Rdc	1,9 + 1,9	Ω
Nominal impedance	ZN	2,0 +2,0	Ω
Resonance frequency	fs	41,9	Hz
Voice coil Diameter		2,5	inch
Shipping weight		16,7	kg

Mechanical Q factor	Qms	4,29	
Electrical Q factor	Qes	0,55	
Total Q factor	Qts	0,49	

Moving mass	Mms	114,2	g
Effective cone area	Sd	176	cm ²
Mechanical resistance	Rms	0	Kg/s
Compliance	Cms	0,13	mm/N
Force factor	BL	18,61	Tm
Equivalent air volume	Vas	16,15	dm ³
X max	tot./lin.	60 / 40	mm
Magnet weight		6,5 / 230	kg/oz

SPL 2,83V/1m	88	dB
--------------	-----------	----

Cone: Paper Kevlar	Spider: Compound
Surround: foam	Coil former: Aluminium
Basket: Aluminium	Dust cap: Paper
Coil: Aluminium Flat wire	

* only 5 sec.



Diameter	
External diameter	213 mm
Installation diameter	188 mm
Installation depth	160 mm
Magnet diameter	180 mm

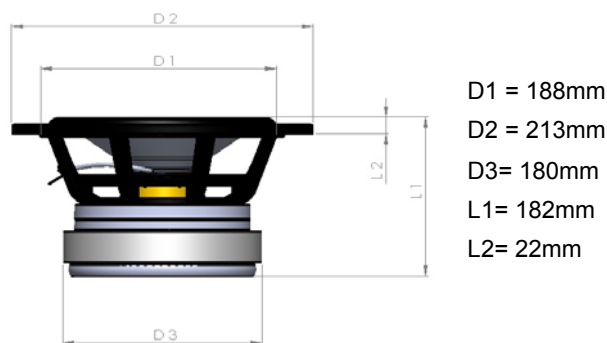

Recommended Boxes (including Ports and Drivers)

Bandpass 6th Order

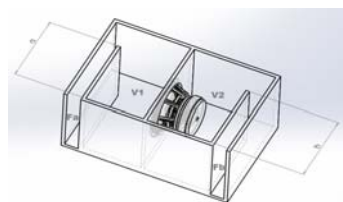

V1 = 35l
V2 = 35l
Fa = 100cm²
Fb = 60 cm²
a = 5 cm
b = 15 cm

Bandpass 4th Order

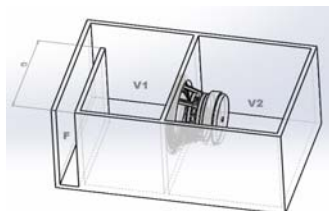

V1 = 35l
V2 = 25l
F = 80 cm²
a = 10 cm

Bandpass 6th Order

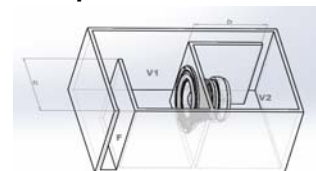

V1 = 37l
V2 = 32l
F = 150cm²
Fb = 60cm²
a = 10cm
b = 15cm

Vented

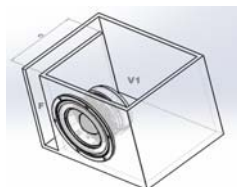

V1 = 39l
F = 100cm²
a = 40 cm

Sealed

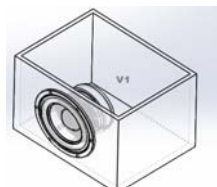

V1 = 29l