

X ARMAGEDDON 18 D2

Speaker Specification

Power	P	1000 / 5000*	RMS/SPL
DC resistance	Rdc	1,9 + 1,9	Ω
Nominal impedance	ZN	2,0 +2,0	Ω
Resonance frequency	fs	29,2	Hz
Voice coil Diameter		2,5	inch
Shipping weight		18,8	kg

Mechanical Q factor	Qms	7,26
Electrical Q factor	Qes	0,53
Total Q factor	Qts	0,49

Moving mass	Mms	337,2	g
Effective cone area	Sd	1134	cm ²
Mechanical resistance	Rms	0	Kg/s
Compliance	Cms	0,07	mm/N
Force factor	BL	16	Tm
Equivalent air volume	Vas	124,2	dm ³
X max	tot./lin.	80 / 40	mm
Magnet weight		6,5 / 230	kg/oz

SPL 2,83V/1m	95	dB
--------------	----	----

Cone: Paper Kevlar Spider: Compound
 Surround: foam Coil former: Aluminium
 Basket: Aluminium Dust cap: Paper
 Coil: Aluminium flat Wire

* only 5 sec.

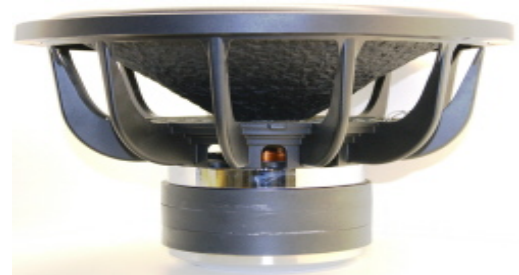

Diameter

External diameter	446 mm
Installation diameter	425 mm
Installation depth	270mm
Magnet diameter	180 mm

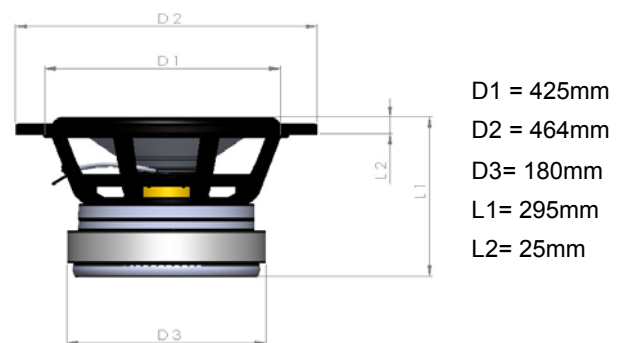

Recommended Boxes (including Ports and Drivers)

Bandpass 6th Order

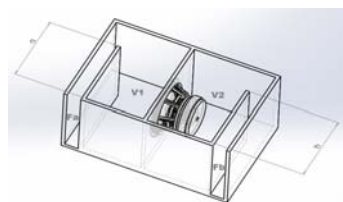

V1 = 110l
 V2 = 125l
 Fa = 350cm²
 Fb = 200 cm²
 a = 5 cm
 b = 15 cm

Bandpass 4th Order

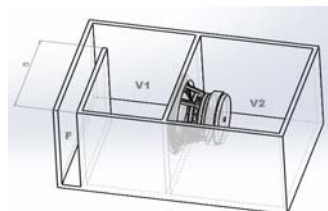

V1 = 135l
 V2 = 80l
 F = 250 cm²
 a = 10 cm

Bandpass 6th Order

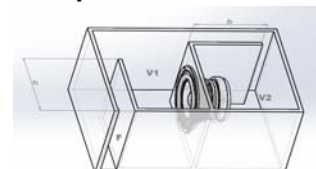

V1 = 125l
 V2 = 125l
 F = 450cm²
 Fb = 200cm²
 a = 10cm
 b = 15cm

Vented

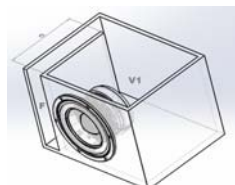

V1 = 135l
 F = 350cm²
 a = 40 cm

Sealed

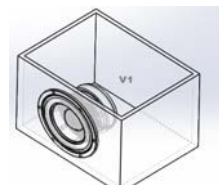

V1 = 80l