

# X15 ARMAGEDDON D1

## Speaker Specification

Power	P	<b>1300 / 6000*</b>	RMS/SPL
DC resistance	Rdc	<b>0,9 + 0,9</b>	Ω
Nominal impedance	ZN	<b>1,0 + 1,0</b>	Ω
Resonance frequency	fs	<b>34,5</b>	Hz
Voice coil Diameter		<b>2,5</b>	inch
Shipping weight		<b>18,3</b>	kg

Mechanical Q factor	Qms	<b>7,88</b>	
Electrical Q factor	Qes	<b>0,51</b>	
Total Q factor	Qts	<b>0,48</b>	

Moving mass	Mms	<b>220,8</b>	g
Effective cone area	Sd	<b>754</b>	cm <sup>2</sup>
Mechanical resistance	Rms	<b>0</b>	Kg/s
Compliance	Cms	<b>0,08</b>	mm/N
Force factor	BL	<b>16,1</b>	Tm
Equivalent air volume	Vas	<b>86,7</b>	dm <sup>3</sup>
X max	tot./lin.	<b>80 / 40</b>	mm
Magnet weight		<b>6,5 / 230</b>	kg/oz

SPL 2,83V/1m	<b>93</b>	dB
--------------	-----------	----

Cone: Paper Kevlar	Spider: Compound
Surround: foam	Coil former: Aluminium
Basket: Aluminium	Dust cap: Paper
Coil: Aluminium flat Wire	

\* only 5 sec.

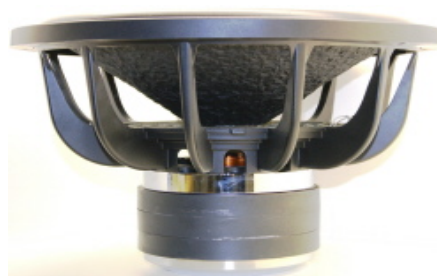

Diameter	
External diameter	389 mm
Installation diameter	358 mm
Installation depth	227 mm
Magnet diameter	180 mm

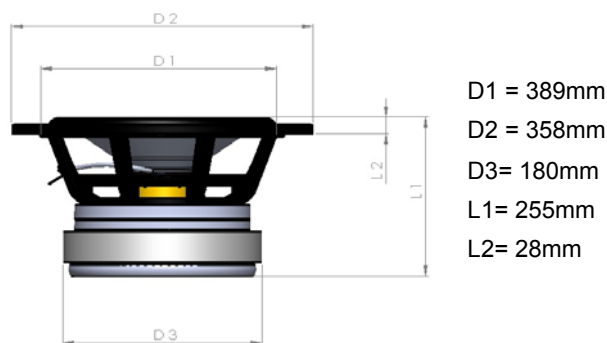

## Recommended Boxes (including Ports and Drivers)

### Bandpass 6th Order

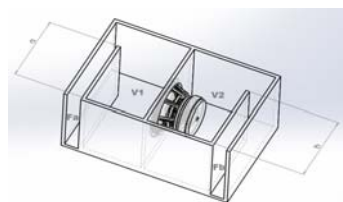

V1 = 90l  
V2 = 100l  
Fa = 250cm<sup>2</sup>  
Fb = 150 cm<sup>2</sup>  
a = 5 cm  
b = 15 cm

### Bandpass 4th Order

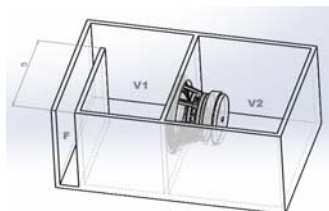

V1 = 90l  
V2 = 60l  
F = 160 cm<sup>2</sup>  
a = 10 cm

### Bandpass 6th Order

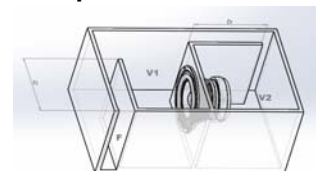

V1 = 90l  
V2 = 90l  
F = 300cm<sup>2</sup>  
Fb = 150cm<sup>2</sup>  
a = 10cm  
b = 15cm

### Vented

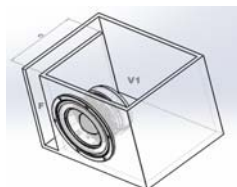

V1 = 100l  
F = 250cm<sup>2</sup>  
a = 40 cm

### Sealed

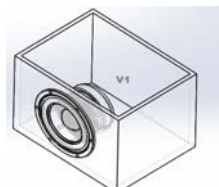

V1 = 60l