

X12 ARMAGEDDON D2

Speaker Specification

Power	P	1300 / 5000*	RMS/SPL
DC resistance	Rdc	1,9 + 1,9	Ω
Nominal impedance	ZN	2,0 +2,0	Ω
Resonance frequency	fs	39,9	Hz
Voice coil Diameter		2,5	inch
Shipping weight		17,8	kg

Mechanical Q factor	Qms	4,65	
Electrical Q factor	Qes	0,52	
Total Q factor	Qts	0,47	

Moving mass	Mms	165,3	g
Effective cone area	Sd	430	cm ²
Mechanical resistance	Rms	0	Kg/s
Compliance	Cms	0,1	mm/N
Force factor	BL	16,3	Tm
Equivalent air volume	Vas	50,4	dm ³
X max	tot./lin.	80 / 40	mm
Magnet weight		6,5 / 230	kg/oz

SPL 2,83V/1m	91	dB
--------------	-----------	----

Cone: Paper Kevlar	Spider: Compound
Surround: foam	Coil former: Aluminium
Basket: Aluminium	Dust cap: Paper
Coil: Aluminium flat Wire	

* only 5 sec.



Diameter	
External diameter	315 mm
Installation diameter	280 mm
Installation depth	186 mm
Magnet diameter	180 mm

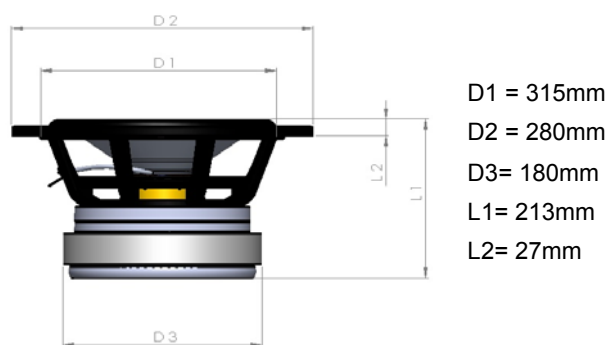

Recommended Boxes (including Ports and Drivers)

Bandpass 6th Order

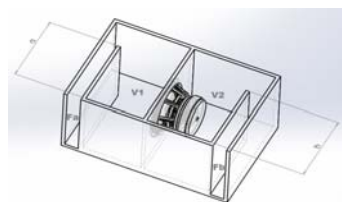

V1 = 65l
V2 = 70l
Fa = 150cm²
Fb = 100 cm²
a = 5 cm
b = 15 cm

Bandpass 4th Order

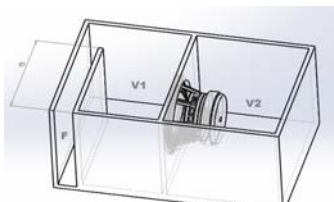

V1 = 65l
V2 = 45l
F = 100 cm²
a = 10 cm

Bandpass 6th Order

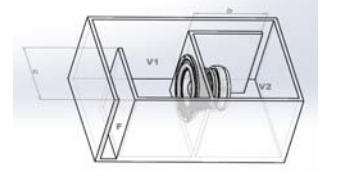

V1 = 65l
V2 = 65l
F = 180cm²
Fb = 80cm²
a = 10cm
b = 15cm

Vented

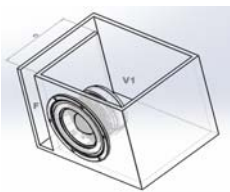

V1 = 70l
F = 120cm²
a = 40 cm

Sealed

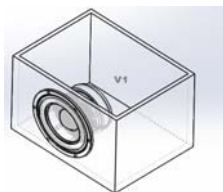

V1 = 45l