

XX15 ARMAGEDDON D1

Speaker Specification

Power	P	2000/15000*	RMS/SPL
DC resistance	Rdc	0,9 + 0,9	Ω
Nominal impedance	ZN	1,0 + 1,0	Ω
Resonance frequency	fs	35,6	Hz
Voice coil Diameter		3	inch
Shipping weight		34,9	kg

Mechanical Q factor	Qms	5,31	
Electrical Q factor	Qes	0,51	
Total Q factor	Qts	0,47	

Moving mass	Mms	293,9	g
Effective cone area	Sd	754	cm ²
Mechanical resistance	Rms	0	Kg/s
Compliance	Cms	0,1	mm/N
Force factor	BL	19,11	Tm
Equivalent air volume	Vas	84,8	dm ³
X max	tot./lin.	80 / 30	mm
Magnet weight		12,4 / 440	kg/oz

SPL 2,83V/1m	94	dB
--------------	-----------	----

Cone: Paper Kevlar	Spider: Compound
Surround: foam	Coil former: Aluminium
Basket: Aluminium	Dust cap: Paper
Coil: Aluminium flat Wire	

* only 5 sec. In special tuned Box



Diameter

External diameter	389 mm
Installation diameter	358 mm
Installation depth	262 mm
Magnet diameter	230 mm

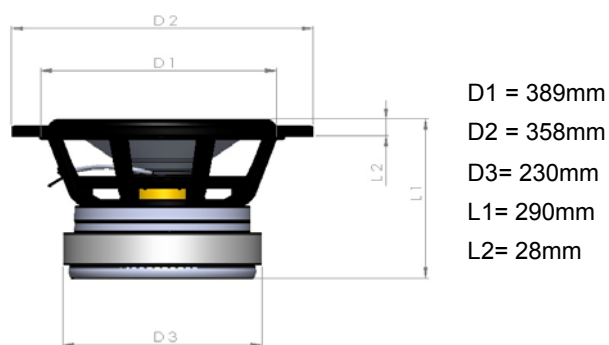

Recommended Boxes (including Ports and Drivers)

Bandpass 6th Order

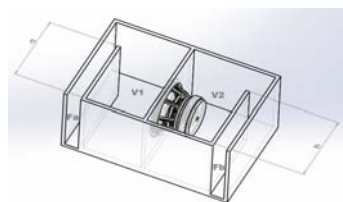

V1 = 100l
V2 = 110l
Fa = 250cm²
Fb = 150 cm²
a = 5 cm
b = 15 cm

Bandpass 4th Order

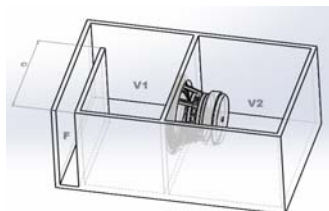

V1 = 110l
V2 = 70l
F = 180 cm²
a = 10 cm

Bandpass 6th Order

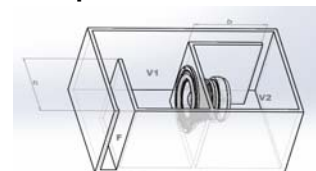

V1 = 100l
V2 = 100l
F = 300cm²
Fb = 150cm²
a = 10cm
b = 15cm

Vented

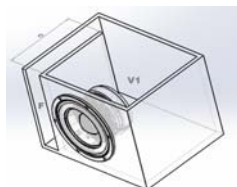

V1 = 110l
F = 300cm²
a = 40 cm

Sealed

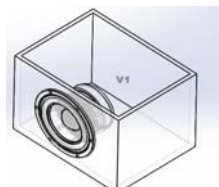

V1 = 70l