

XS8 D2

Speaker Specification

Power	P	500 / 1000*	RMS/SPL
DC resistance	Rdc	1,9 + 1,9	Ω
Nominal impedance	ZN	2,0 +2,0	Ω
Resonance frequency	fs	39,4	Hz
Voice coil Diameter		2,5	inch
Shipping weight		7,5	kg

Mechanical Q factor	Qms	5,8
Electrical Q factor	Qes	0,48
Total Q factor	Qts	0,44

Moving mass	Mms	99,16	g
Effective cone area	Sd	176	cm ²
Mechanical resistance	Rms	0	Kg/s
Compliance	Cms	0,14	mm/N
Force factor	BL	16,34	Tm
Equivalent air volume	Vas	16,28	dm ³
X max	tot./lin.	54 / 12	mm
Magnet weight		1,7 / 60	kg/oz

SPL 2,83V/1m	87	dB
--------------	-----------	----

Cone: Paper Kevlar
 Surround: foam
 Basket: Aluminium
 Coil: Kupper

Spider: Compound
 Coil former: Aluminium
 Dust cap: Paper

* only 5 sec.



Diameter

External diameter	213 mm
Installation diameter	188 mm
Installation depth	125 mm
Magnet diameter	150 mm

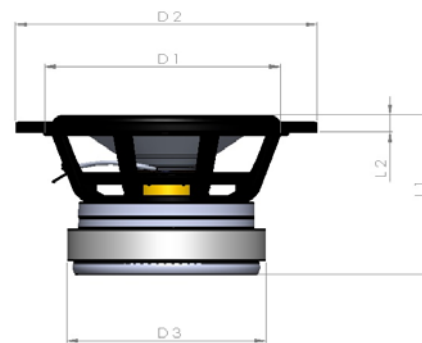

D1 = 188mm
 D2 = 213mm
 D3 = 180mm
 L1 = 147mm
 L2 = 22mm

Recommended Boxes (including Ports and Drivers)

Bandpass 6th Order

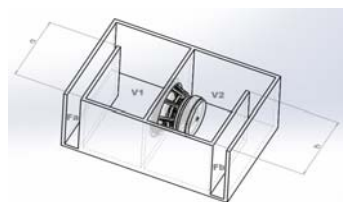

V1 = 28l
 V2 = 28l
 Fa = 100cm²
 Fb = 60 cm²
 a = 5 cm
 b = 15 cm

Bandpass 4th Order

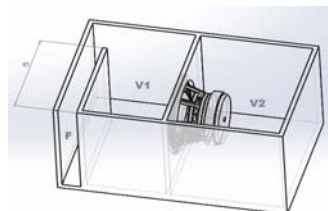

V1 = 28l
 V2 = 18l
 F = 80 cm²
 a = 10 cm

Bandpass 6th Order

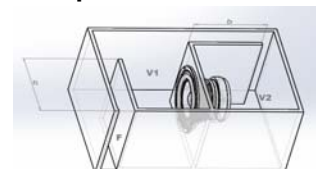

V1 = 30l
 V2 = 25l
 F = 150cm²
 Fb = 60cm²
 a = 10cm
 b = 15cm

Vented

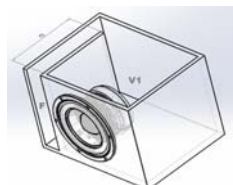

V1 = 32l
 F = 100cm²
 a = 40 cm

Sealed

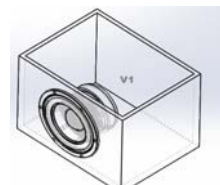

V1 = 22l