

XS15 D2

Speaker Specification

Power	P	500 / 1000*	RMS/SPL
DC resistance	Rdc	1,9 + 1,9	Ω
Nominal impedance	ZN	2,0 +2,0	Ω
Resonance frequency	fs	34,8	Hz
Voice coil Diameter		2,5	inch
Shipping weight		10,5	kg

Mechanical Q factor	Qms	6,37
Electrical Q factor	Qes	0,44
Total Q factor	Qts	0,41

Moving mass	Mms	209	g
Effective cone area	Sd	754	cm ²
Mechanical resistance	Rms	0	Kg/s
Compliance	Cms	0,13	mm/N
Force factor	BL	14,85	Tm
Equivalent air volume	Vas	84,2	dm ³
X max	tot./lin.	54 / 12	mm
Magnet weight		1,7 / 60	kg/oz

SPL 2,83V/1m	92	dB
--------------	-----------	----

Cone: Paper Kevlar
 Surround: foam
 Basket: Aluminium
 Coil: Kupper

Spider: Compound
 Coil former: Aluminium
 Dust cap: Paper

* only 5 sec.



Diameter

External diameter	389 mm
Installation diameter	358 mm
Installation depth	192 mm
Magnet diameter	150 mm

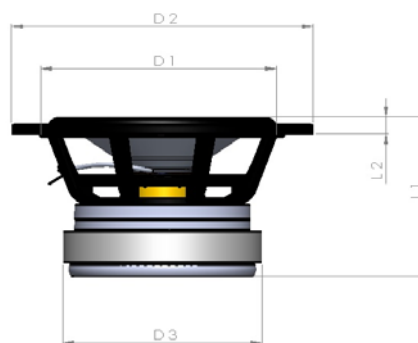

D1 = 389mm
 D2 = 358mm
 D3 = 150mm
 L1 = 220mm
 L2 = 28mm

Recommended Boxes (including Ports and Drivers)

Bandpass 6th Order

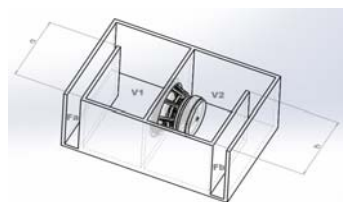

V1 = 85l
 V2 = 95l
 Fa = 250cm²
 Fb = 150 cm²
 a = 5 cm
 b = 15 cm

Bandpass 4th Order

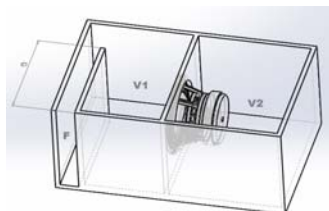

V1 = 85l
 V2 = 55l
 F = 160 cm²
 a = 10 cm

Bandpass 6th Order

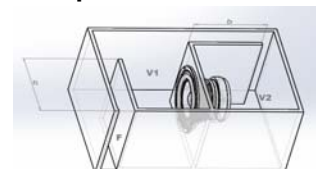

V1 = 85l
 V2 = 85l
 F = 300cm²
 Fb = 150cm²
 a = 10cm
 b = 15cm

Vented

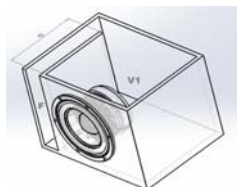

V1 = 95l
 F = 250cm²
 a = 40 cm

Sealed

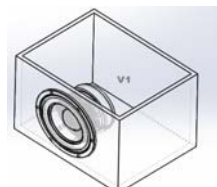

V1 = 55l