

XS12 D4

Speaker Specification

Power	P	500 / 1000*	RMS/SPL
DC resistance	Rdc	3,6 + 3,6	Ω
Nominal impedance	ZN	4,0 + 4,0	Ω
Resonance frequency	fs	37,8	Hz
Voice coil Diameter		2,5	inch
Shipping weight		9,5	kg

Mechanical Q factor	Qms	6,2
Electrical Q factor	Qes	0,45
Total Q factor	Qts	0,42

Moving mass	Mms	145,1	g
Effective cone area	Sd	430	cm ²
Mechanical resistance	Rms	0	Kg/s
Compliance	Cms	0,13	mm/N
Force factor	BL	15,98	Tm
Equivalent air volume	Vas	49,3	dm ³
X max	tot./lin.	54 / 12	mm
Magnet weight		1,7 / 60	kg/oz

SPL 2,83V/1m	89	dB
--------------	-----------	----

Cone: Paper Kevlar
 Surround: foam
 Basket: Aluminium
 Coil: Kupper

Spider: Compound
 Coil former: Aluminium
 Dust cap: Paper

* only 5 sec.



Diameter

External diameter	315 mm
Installation diameter	280 mm
Installation depth	151 mm
Magnet diameter	150 mm

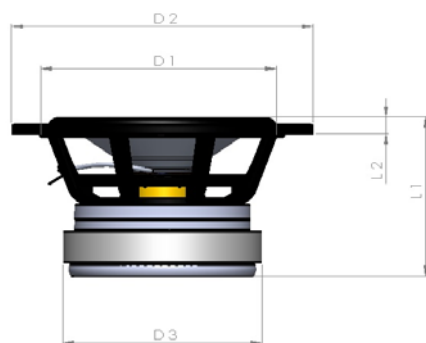

D1 = 315mm
 D2 = 280mm
 D3 = 150mm
 L1 = 178mm
 L2 = 27mm

Recommended Boxes (including Ports and Drivers)

Bandpass 6th Order

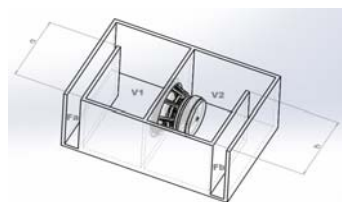

V1 = 65l
 V2 = 70l
 Fa = 150cm²
 Fb = 100 cm²
 a = 5 cm
 b = 15 cm

Bandpass 4th Order

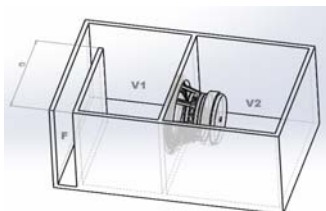

V1 = 65l
 V2 = 45l
 F = 100 cm²
 a = 10 cm

Bandpass 6th Order

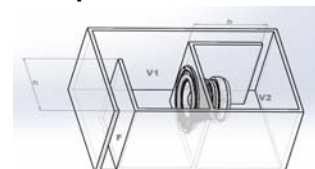

V1 = 65l
 V2 = 65l
 F = 180cm²
 Fb = 80cm²
 a = 10cm
 b = 15cm

Vented

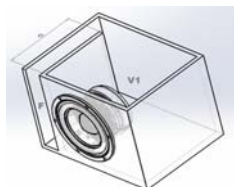

V1 = 70l
 F = 120cm²
 a = 40 cm

Sealed

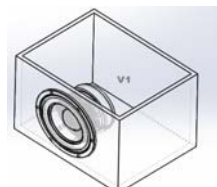

V1 = 45l