

XXX15 ARMAGEDDON D1

Speaker Specification

Power	P	2500/25000*	RMS/SPL
DC resistance	Rdc	0,9 + 0,9	Ω
Nominal impedance	ZN	1,0 + 1,0	Ω
Resonance frequency	fs	37,4	Hz
Voice coil Diameter		3	inch
Shipping weight		41,9	kg

Mechanical Q factor	Qms	5,01	
Electrical Q factor	Qes	0,54	
Total Q factor	Qts	0,49	

Moving mass	Mms	342,1	g
Effective cone area	Sd	754	cm ²
Mechanical resistance	Rms	0	Kg/s
Compliance	Cms	0,1	mm/N
Force factor	BL	20,09	Tm
Equivalent air volume	Vas	79,1	dm ³
X max	tot./lin.	80 / 40	mm
Magnet weight		16,5 / 580	kg/oz

SPL 2,83V/1m	95	dB
--------------	-----------	----

Cone: Paper Kevlar	Spider: Compound
Surround: foam	Coil former: Aluminium
Basket: Aluminium	Dust cap: Paper
Coil: Aluminium flat Wire	

* only 5 sec. In special tuned Box

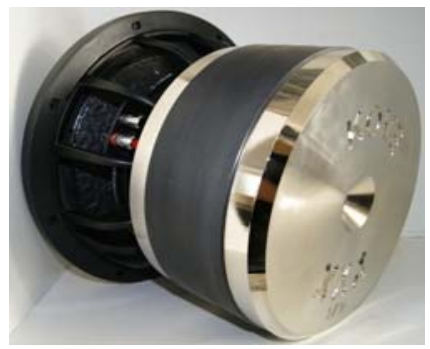

Diameter	
External diameter	389 mm
Installation diameter	358 mm
Installation depth	267 mm
Magnet diameter	250 mm

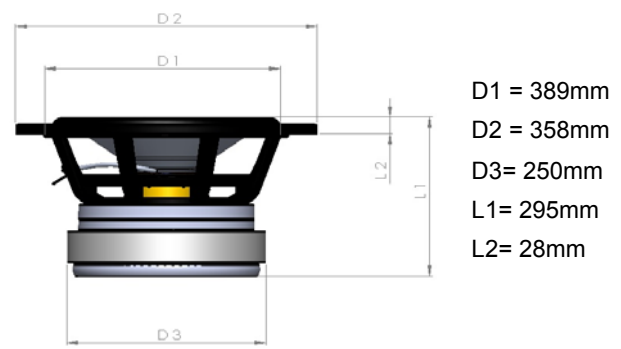

Recommended Boxes (including Ports and Drivers)

Bandpass 6th Order

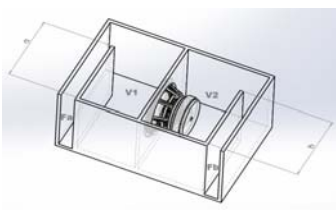

V1 = 110l
V2 = 120l
Fa = 250cm²
Fb = 150 cm²
a = 5 cm
b = 15 cm

Bandpass 4th Order

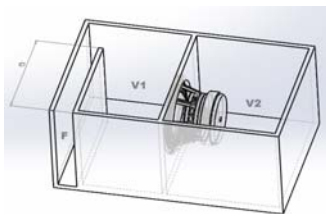

V1 = 120l
V2 = 75l
F = 180 cm²
a = 10 cm

Bandpass 6th Order

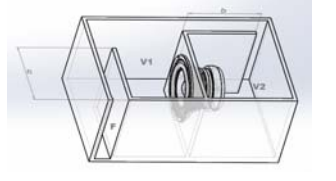

V1 = 110l
V2 = 110l
F = 300cm²
Fb = 150cm²
a = 10cm
b = 15cm

Vented

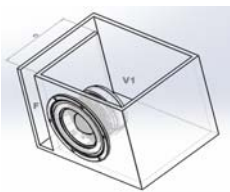

V1 = 120l
F = 300cm²
a = 40 cm

Sealed

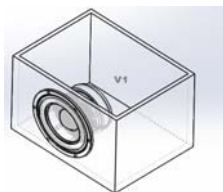

V1 = 75l